

•MAŁY•KONSTRUKTOR•
•CONSTRUCTOR•
JUNIOR



4+

55



№2587





SPOSÓB UŻYCIA NARZĘDZI

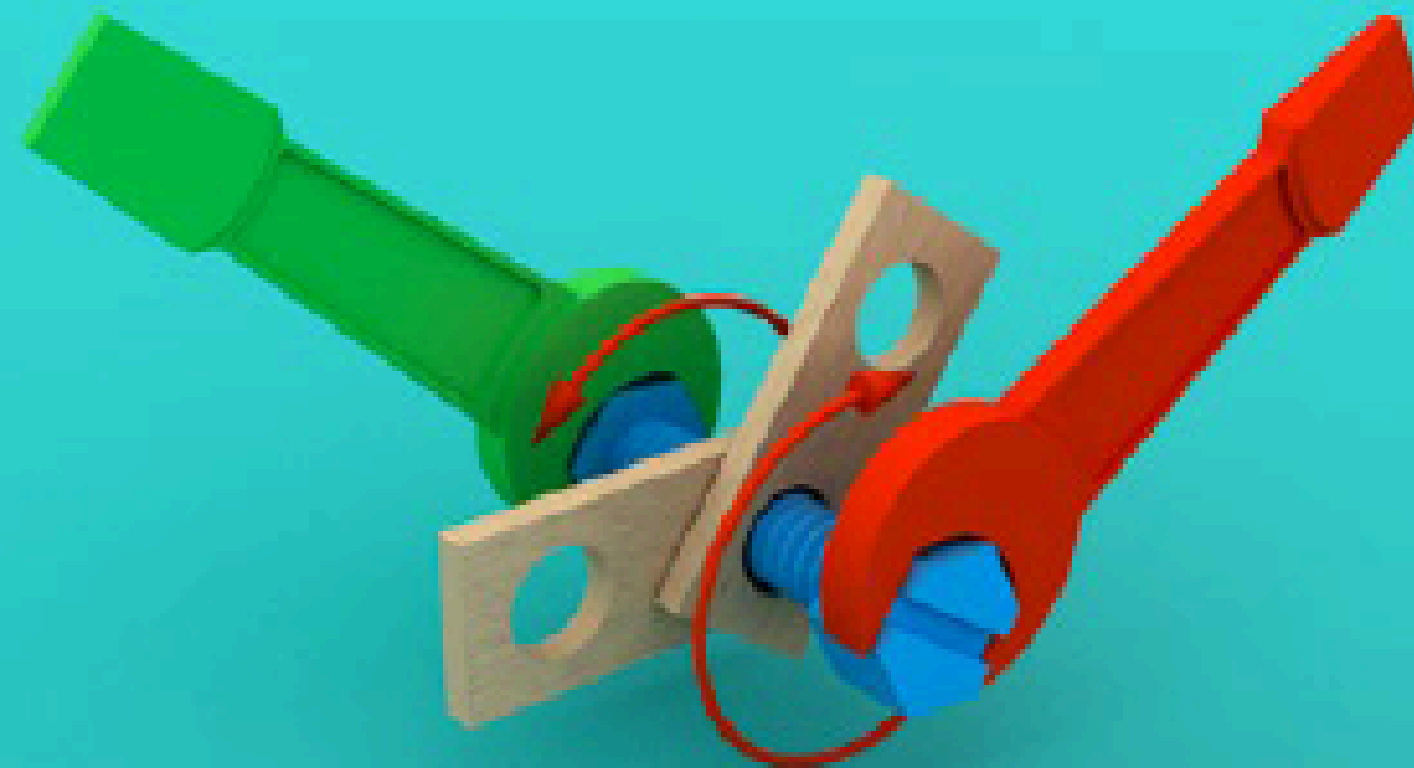
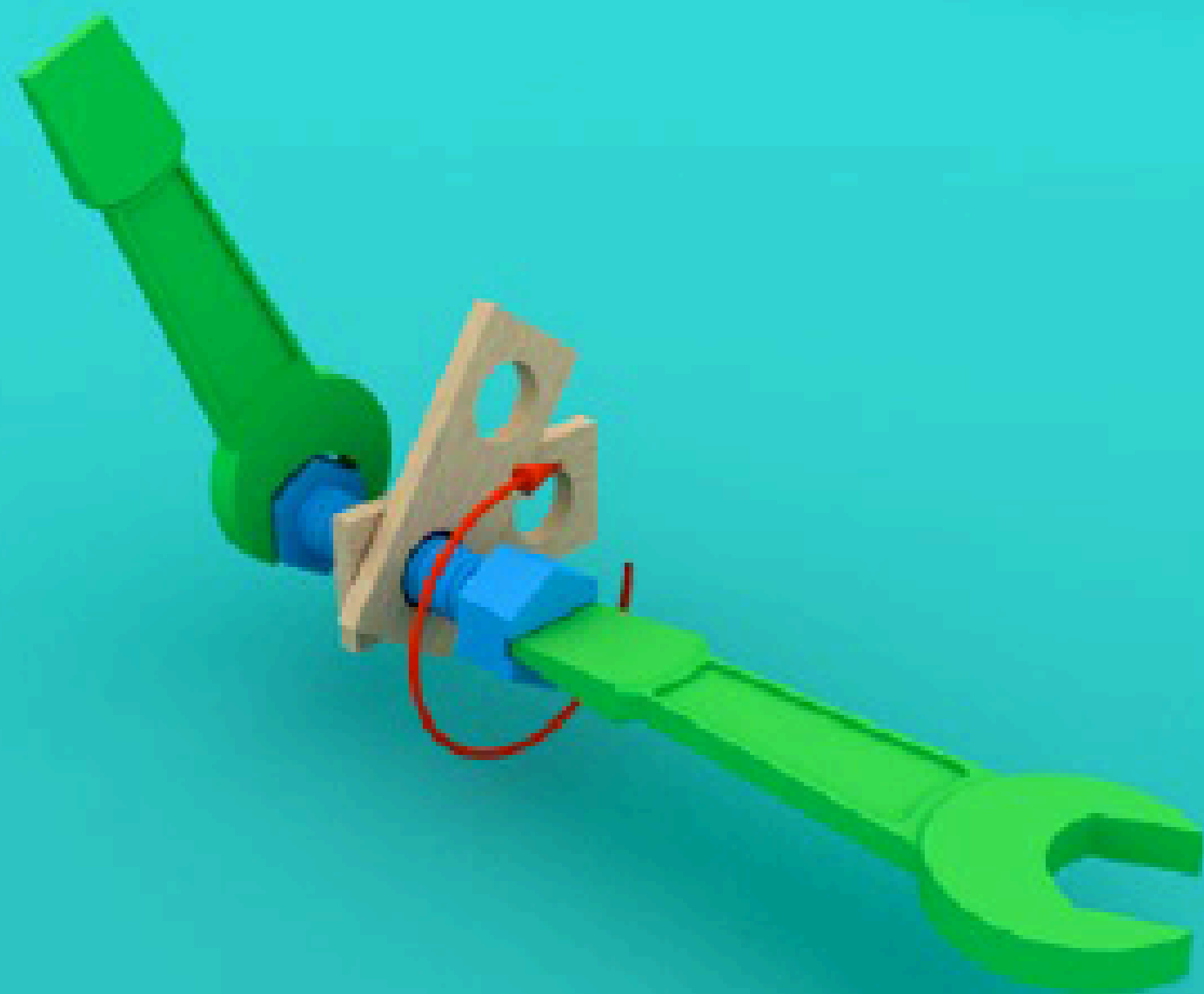

Spis elementów do montażu:

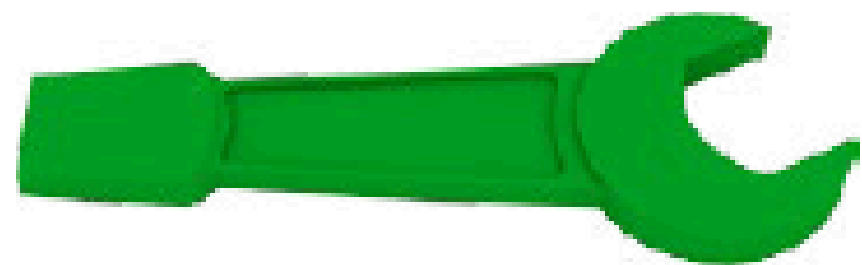

klucz x 2

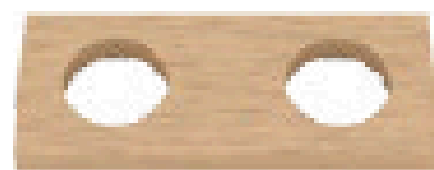

D02 x 2

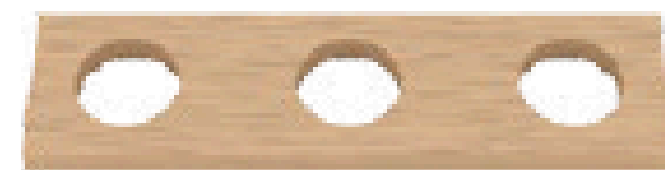

D03 x 2

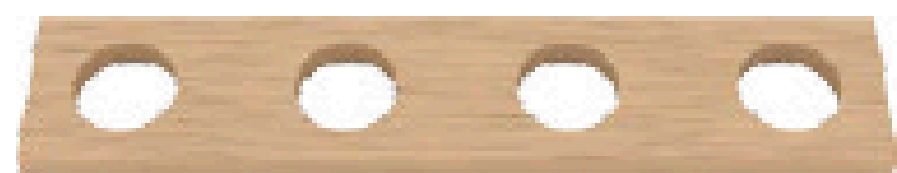

D04 x 4

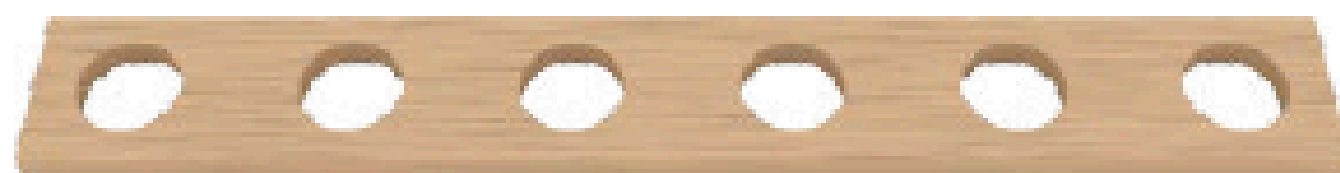

D06 x 2



0705 x 4

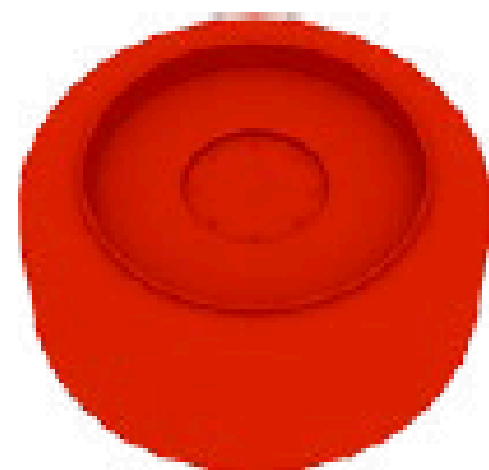

0716 x 4



Wd12h160 x 2

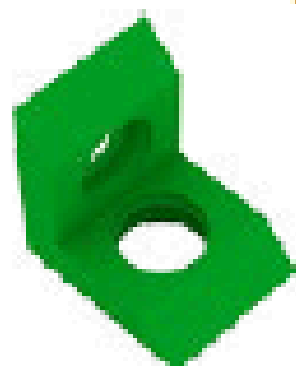

KP001 x 2

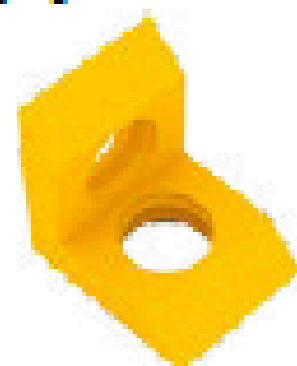

KP001 x 6



NP001 x 10



SP001 x 9



SP001 x 6



SP002 x 2

 x 2

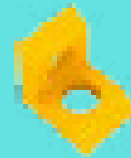
 x 2

 x 2

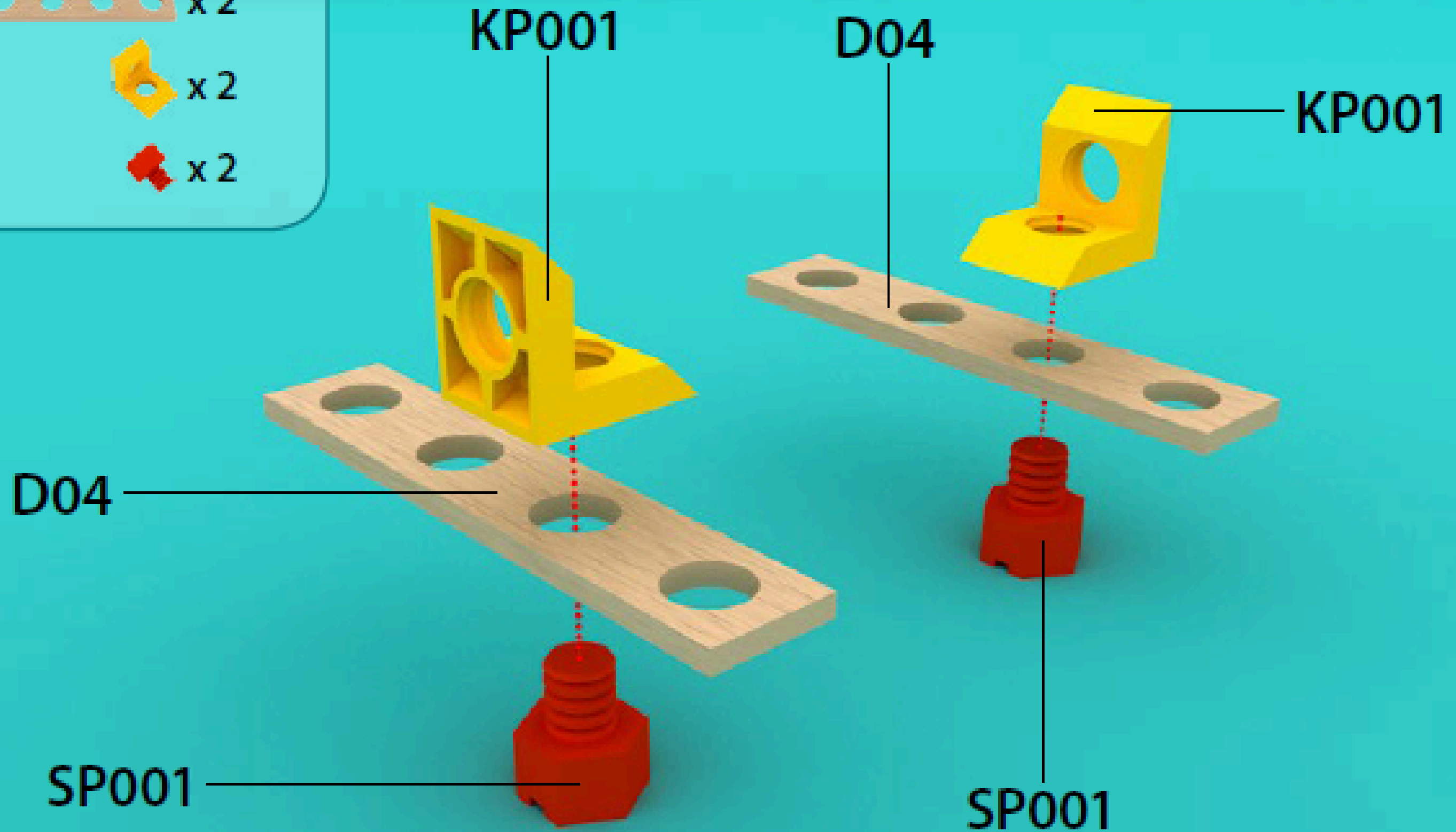

1

NP001

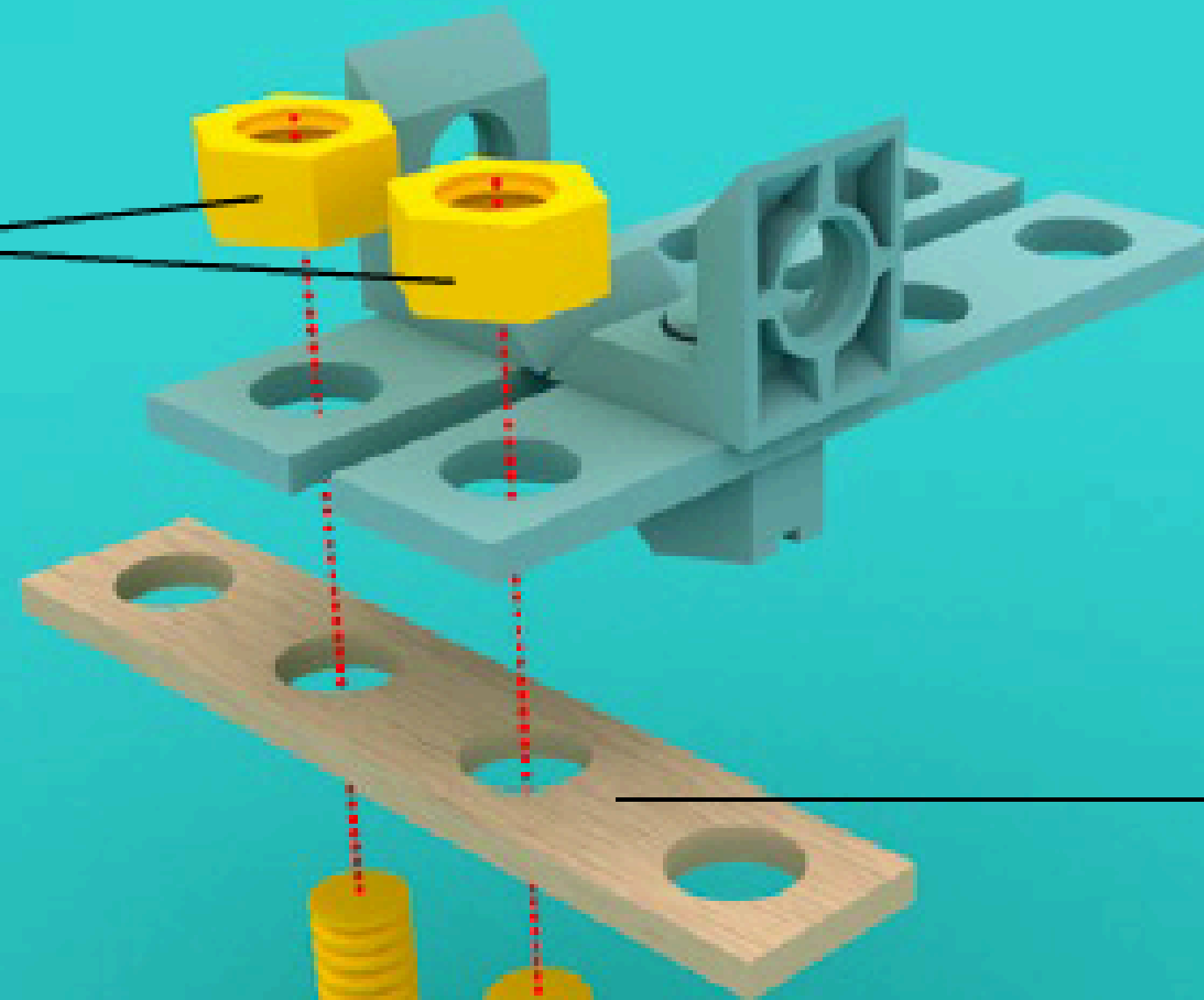

D04

SP002

 x 1

 x 2

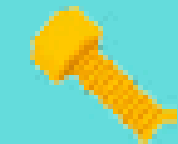
 x 2

 x 2

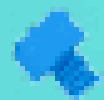
 x 2

SP001



D06



D06

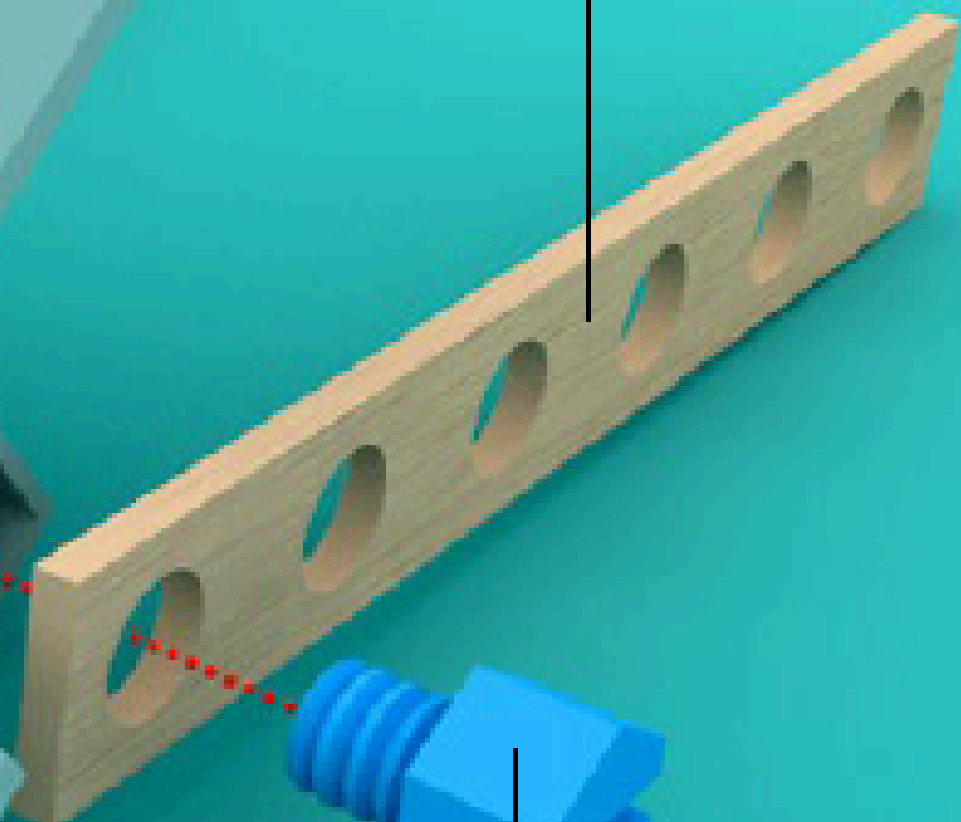

SP001

3

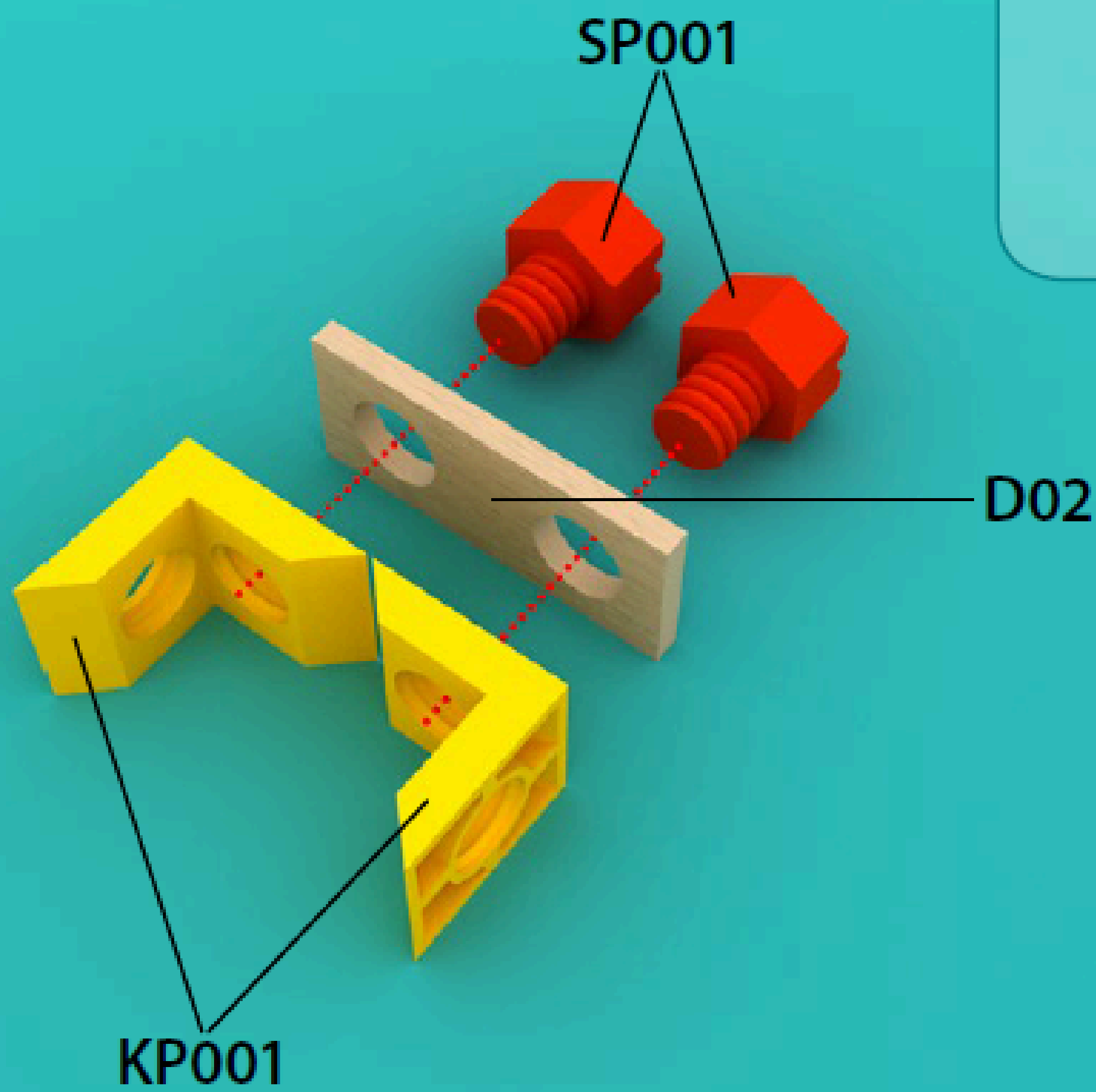

-  x 1
-  x 2
-  x 2

 x2

 x2

D03

SP001

D03

SP001

5

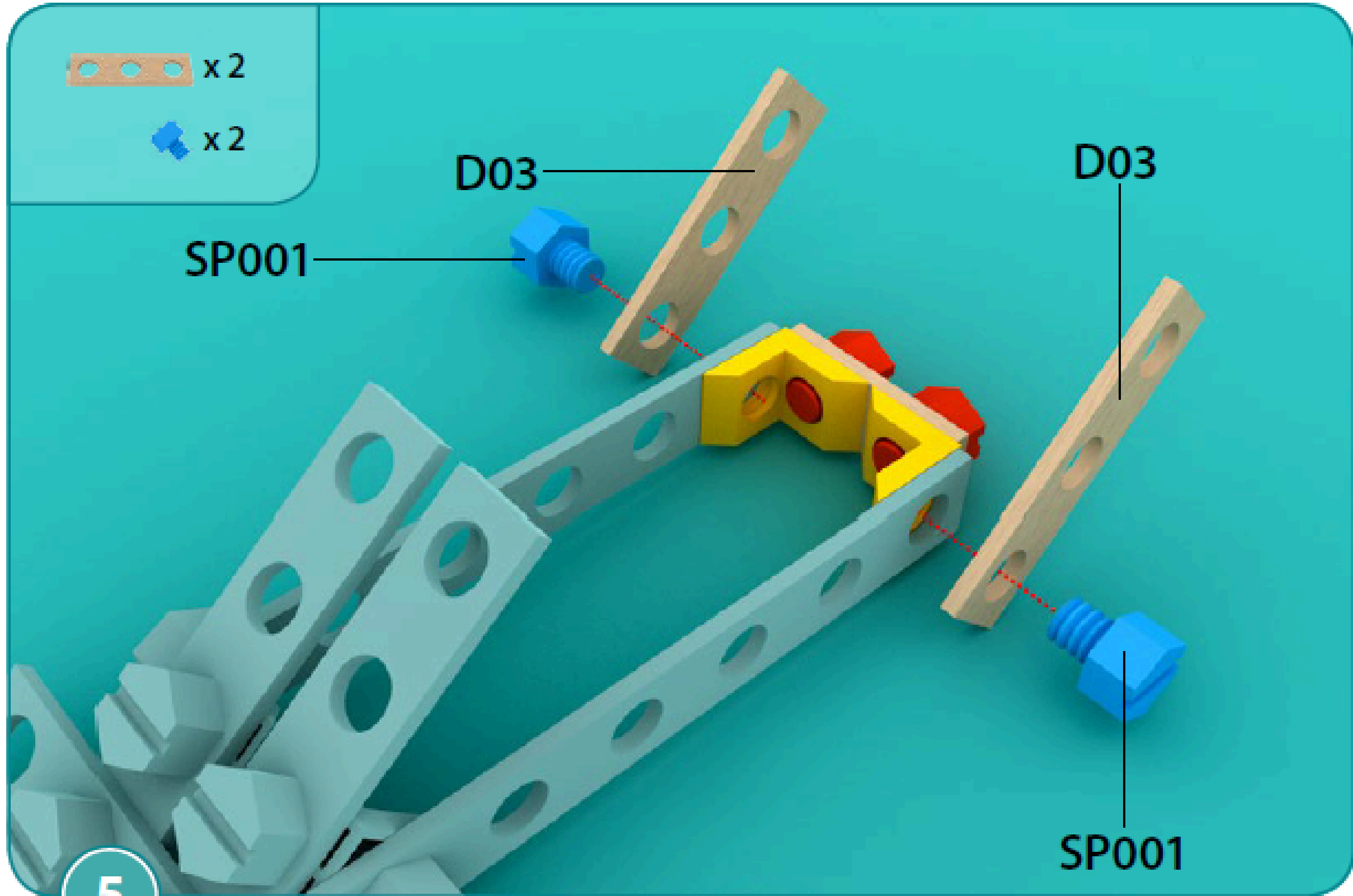

SP001



x 1

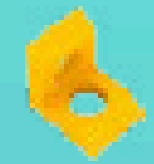

x 2



x 2

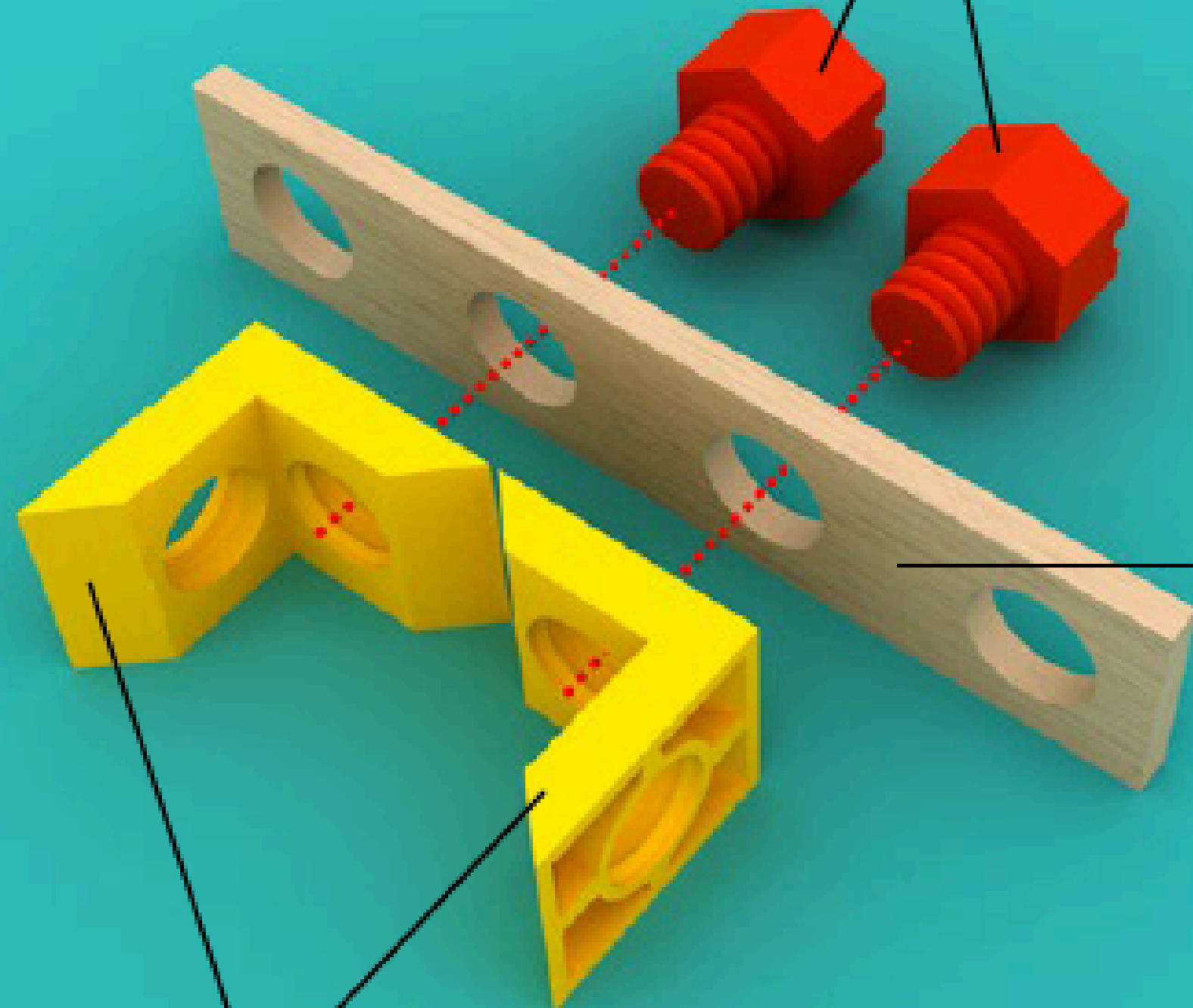

D04

KP001

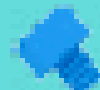
 x 2

SP001

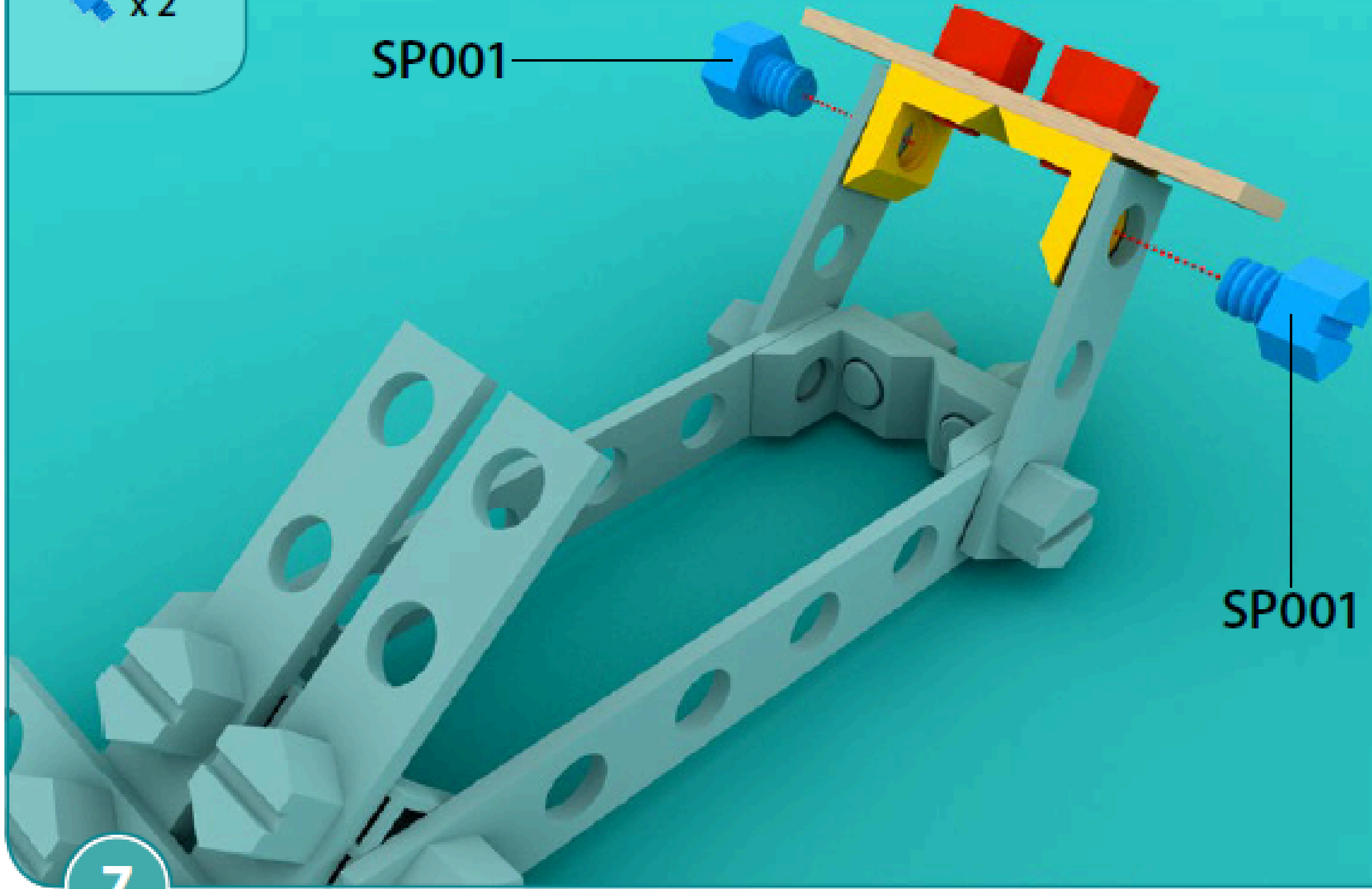

SP001

7

 x 1

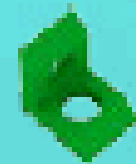
 x 2

 x 2

KP001

SP001

D02

SP001

KP001

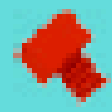
 x 1

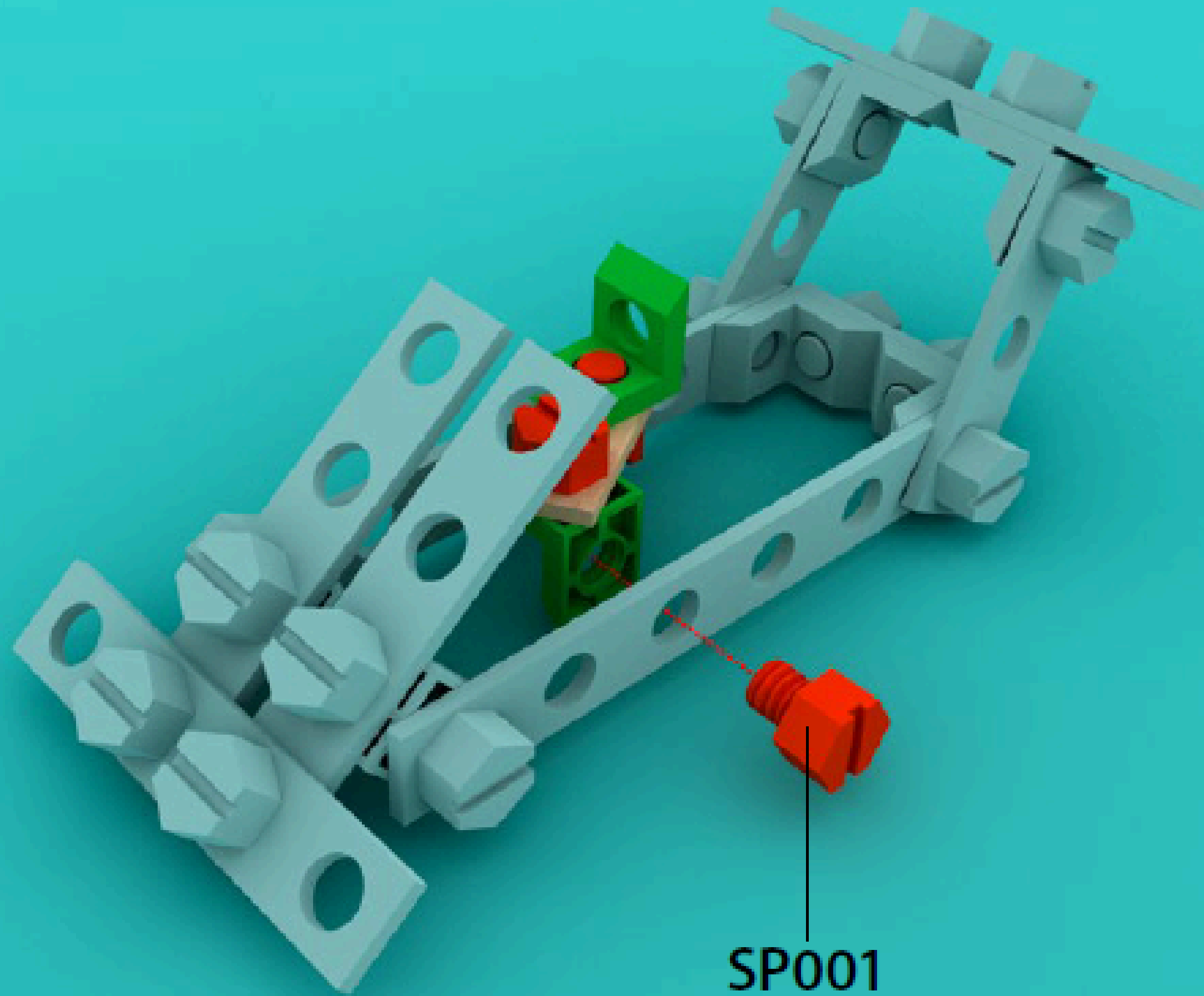

SP001

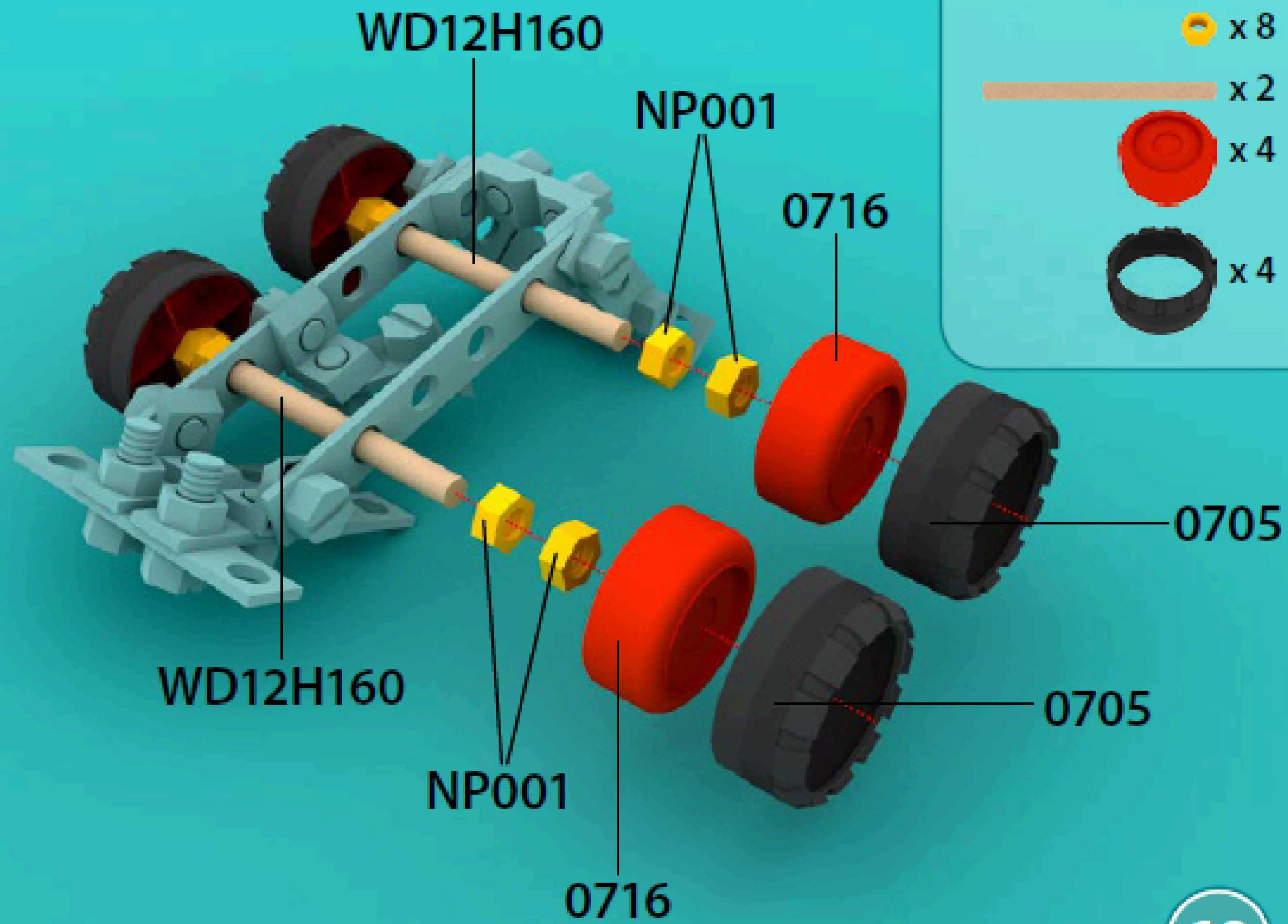

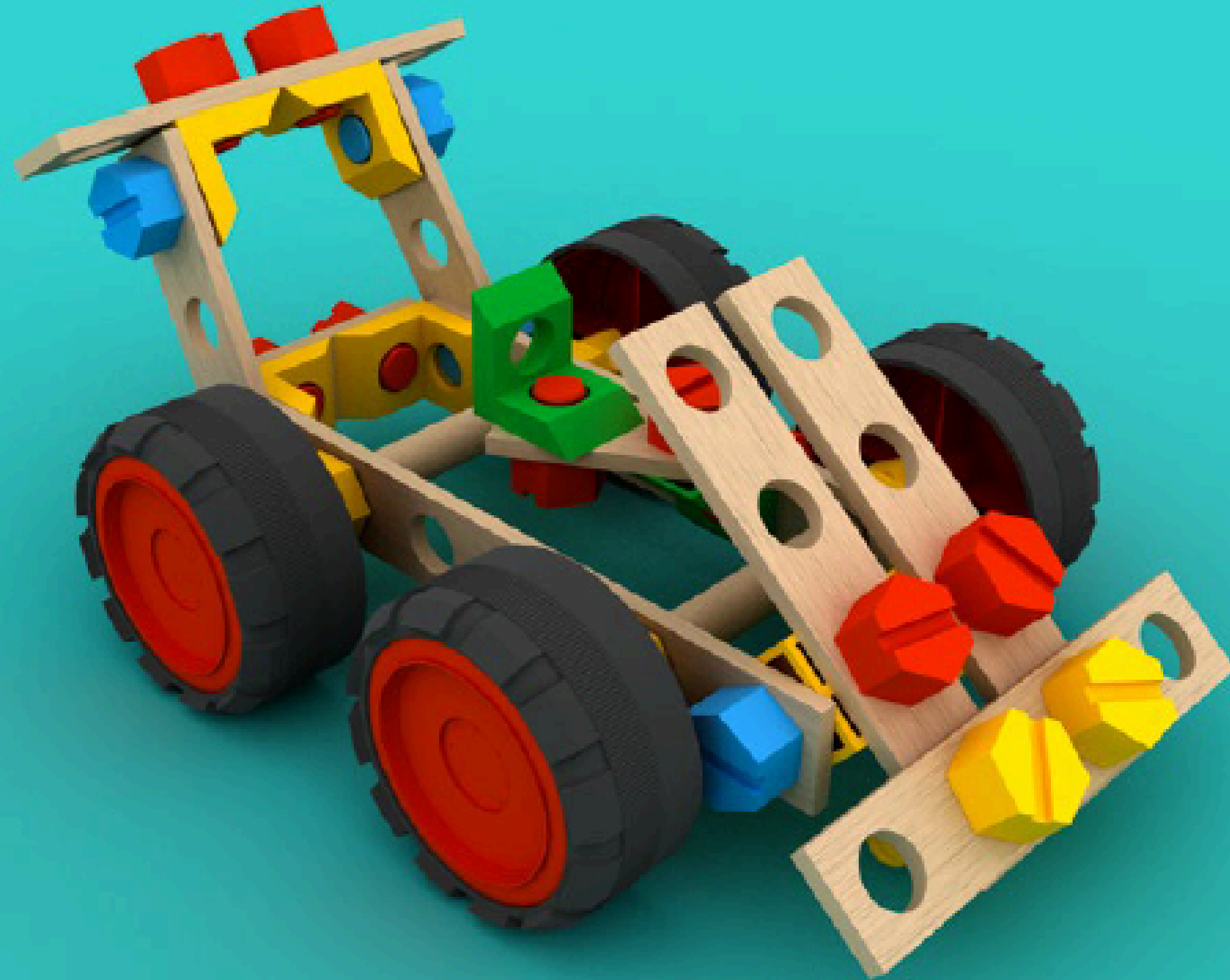

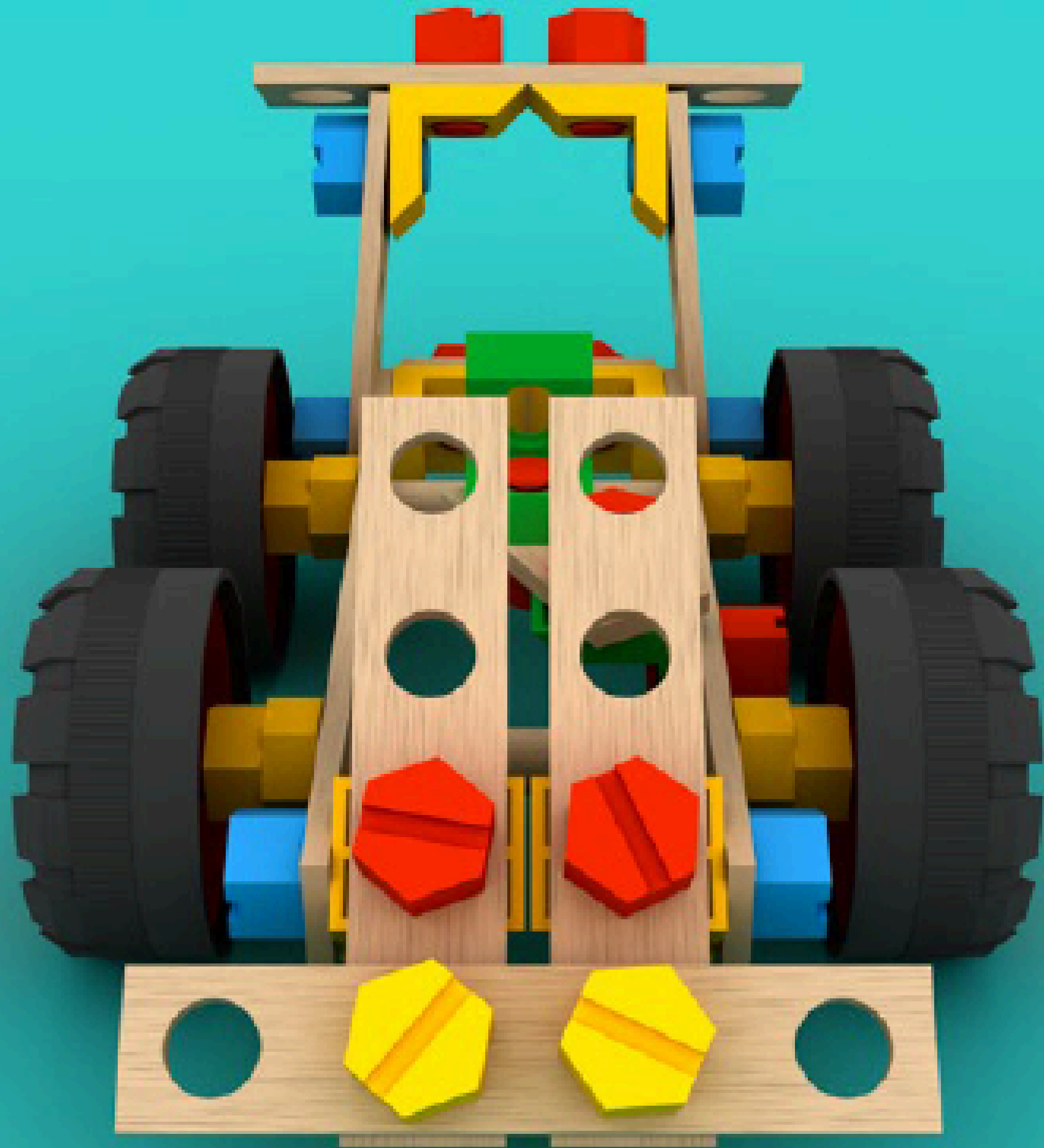

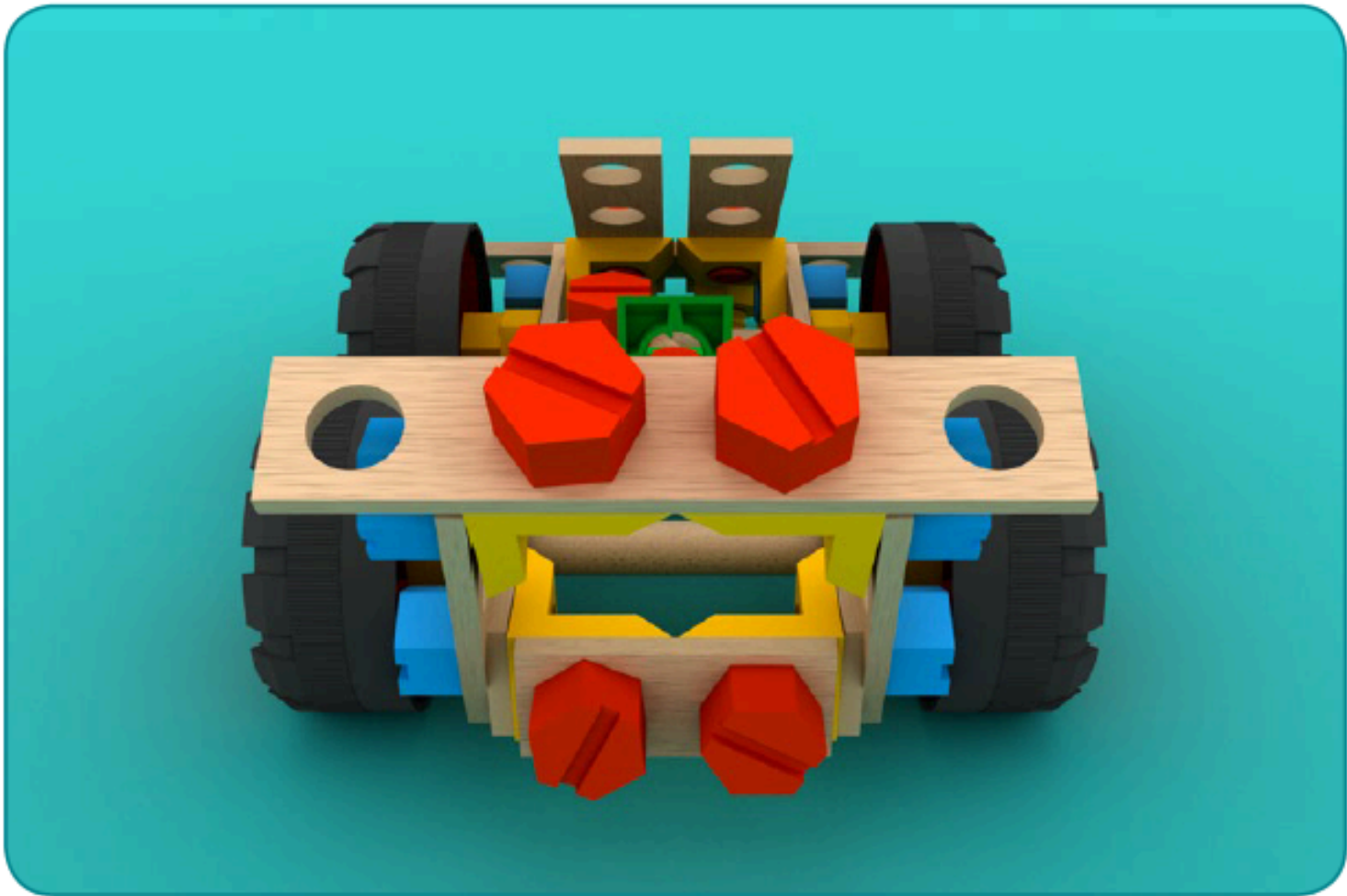
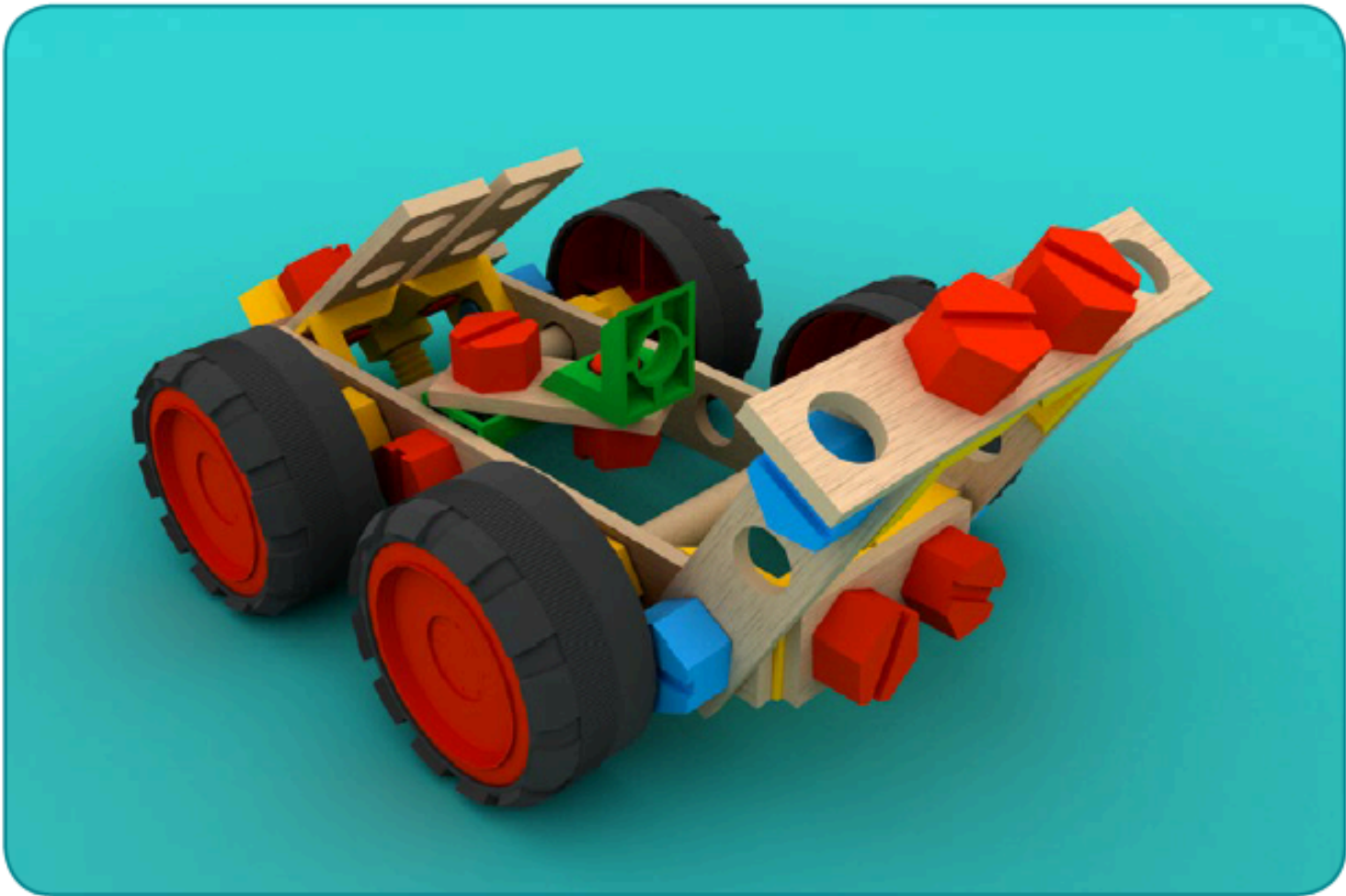

PL: Ostrzeżenia! Nieodpowiednie dla dzieci w wieku poniżej 3 lat. Zestaw zawiera małe elementy – niebezpieczeństwo zakrztuszenia. Prosimy zachować opakowanie ze względu na podane informacje. **EN:** Warnings! Unsuitable for children under the age of 3. Contains small parts – choking hazard. Keep the box for future reference. **DE:** Achtung! Nicht für Kinder unter 3 Jahren geeignet. Enthält kleine Teile, die verschluckt werden können – Erstickungsgefahr. Verpackung für spätere Rückfragen aufbewahren. **FR:** Attention! Ne convient pas aux enfants de moins de 3 ans. Contient des petits éléments pouvant être avalés et engendrer un risque d'étouffement. Documentation à lire et à conserver pour consultation ultérieure. **ES:** ¡Advertencia! No recomendable para niños de 3 años o menores. Peligro de asfixia – piezas pequeñas. Conserve la caja para futuras referencias. **NL:** Waarschuwing! Niet geschikt voor kinderen jonger dan drie jaar. Bevat kleine onderdelen – verstikkingsgevaar opleveren. Bewaar de verpakking, er staat belangrijke informatie op. **CZ:** Upozornění! Nevhodné pro děti do 3 let. Balení obsahuje malé dílky – nebezpečí udušení. Zachovejte prosím obal ze vzhledu na uvedené informace. **SK:** Upozornenia! Nevhodné pre deti vo veku do 3 rokov. Súprava obsahuje malé casti – hrozí nebezpečenstvo udusenía. Obal uschovajte vzhľadom na dôležité informácie, ktoré sa na nom nachádzajú.



www.alexander.com.pl